

# Data Sheet



Article number: 203250M1080A1S

Description: E+G levelling foot

GN 32-50-M10-80-A1-S

Note: S Without nut, External hexagon at the bottom

## Measures

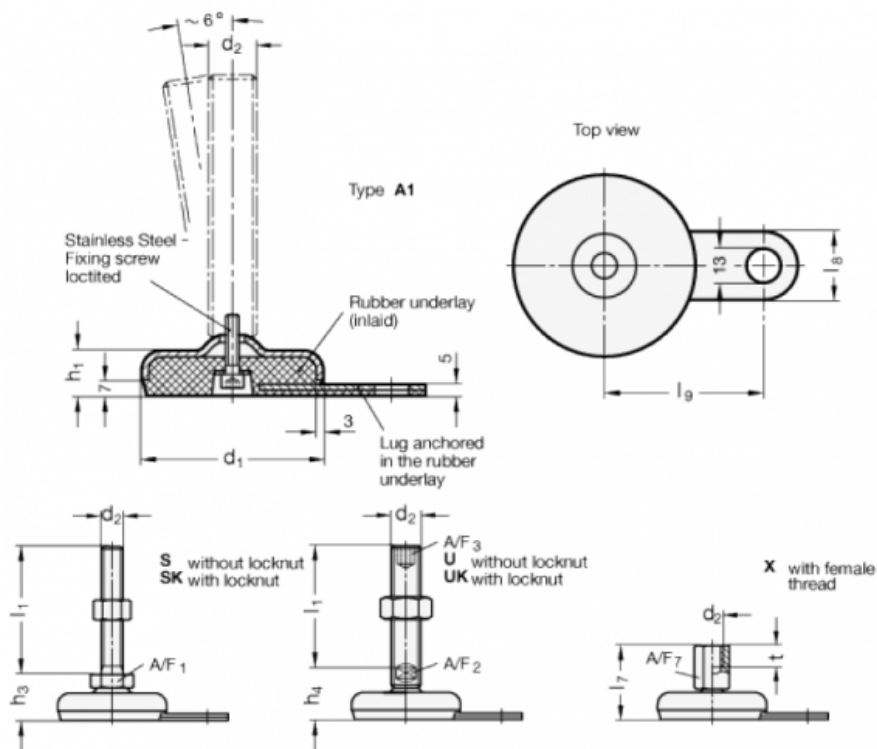

A/F1	=	17
d1	=	50
d2	=	M10
h1	=	18
h3	=	26
l1	=	80
l8	=	25
l9	=	45